

## Finger Touch Unit

Model name FT-01

User's Manual

Thank you for purchasing a Finger Touch Unit specially designed for Hitachi LCD projectors. Be sure to read this manual and the User's Manual supplied with the LCD projector before using this product. After you have finished reading these documents, put them away in a safe place for future reference.

**Disclaimer**

- The content of this manual and the specifications of the product it describes are subject to change without prior notice.
- Note that Hitachi will accept no liability whatsoever for injuries and damages arising from incorrect use or handling that exceeds normal operating limits.

## Table of Contents



	
Safety Symbols.....	2
Overview .....	2
Regulatory notices .....	6
About Electro-Magnetic Interference .....	6
About Waste Electrical and Electronic equipment .....	7
IN the US.....	7
Contents of package .....	8
Part names .....	9
Installation .....	10
Installation Precautions.....	10
Installation Procedure .....	12
Finger Touch Unit adjustment procedure .....	17
Basic Finger Touch Operations .....	23
Inspection and Cleaning .....	23
Troubleshooting .....	24
Specifications .....	28

**NOTE** • The information in this manual is subject to change without notice.

- The illustrations in this manual are for illustrative purposes. They may differ slightly from your product.
- The manufacturer assumes no responsibility for any errors that may appear in this manual.
- The reproduction, transfer or copy of all or any part of this document is not permitted without express written consent.

## Safety Symbols

The following symbols are used in this manual to help you use this product safely and correctly, and to prevent injury to yourself and others or damage to property. Read through the safety instructions below so you can operate the product correctly.

 <b>WARNING</b>	<p>This symbol indicates information that, if ignored, could result in serious personal injury or even death due to incorrect handling.</p>
 <b>CAUTION</b>	<p>This symbol indicates information that, if ignored, could result in personal injury or physical damage due to incorrect handling.</p>



### **Indicates an action that requires caution.**

This symbol is accompanied by text indicating that careful attention is needed.



### **Indicates a prohibited action.**

This symbol is accompanied by text indicating an action that must not be taken.



### **Indicates a mandatory action.**





This symbol is accompanied by text indicating an action that must be taken.

## Overview





- This is an optional product for the Hitachi LCD projectors.
- When this product is installed on a screen, you can use your finger to touch the screen to perform computer operations and draw images.

For details on the models where this product can be installed, see the Hitachi website.

 **WARNING**

	<ul style="list-style-type: none"> <li>■ This device is classified as a class 1 laser product.</li> <li>• If the laser beam is pointed directly at the eyes, it can cause an eye injury.</li> <li>• Do not look directly into the laser output port.</li> <li>• Do not point the laser beam towards people.</li> <li>• Do not allow children to use.</li> <li>• Use the Finger Touch Unit by securing it correctly to the screen.</li> </ul>
	<ul style="list-style-type: none"> <li>■ If a problem arises, immediately disconnect the USB cable. Continued use of the device when it is not functioning properly can result in a fire or electrical shock. If any of the following situations arises, immediately stop usage, disconnect the USB cable from the Finger Touch Unit or computer, and contact your dealer or service company.</li> <li>• Smoke comes out of the device, or it makes an unusual smell or sound.</li> <li>• A foreign object or liquid (such as metal or water) gets inside the device.</li> <li>• The device is dropped or subjected to severe impact.</li> <li>• The main device or connecting cable is damaged.</li> </ul> <p>Never attempt to repair the device yourself. This is extremely dangerous.</p>
	<ul style="list-style-type: none"> <li>■ Notes when using around children and pets.</li> </ul> <p>Improper usage can result in a fire, electrical shock, injury, burn, visual impairment, or other accident. Also, the small parts can be swallowed by children and pets. Keep in a location out of the reach of children and pets. If a part of this device is swallowed, seek medical attention immediately.</p>
	<ul style="list-style-type: none"> <li>■ Do not insert foreign objects or liquids.</li> </ul> <p>Doing so may cause a fire or electrical shock. If a flammable gas or liquid gets inside the device, it could ignite or explode, resulting in a fire or injury. Do not place wet objects, small objects, or objects containing gases or liquid near this device. Do not use sprays (aerosol products) near this device. If a foreign object or liquid gets inside the device, immediately stop use, disconnect the USB cable, and contact your dealer or service company.</p>
	<ul style="list-style-type: none"> <li>■ Do not allow the device to get wet.</li> </ul> <p>If the device, power cable, or other parts get wet, a fire or electrical shock could occur. Do not splash water on the device, or place it in a location exposed to water, rain, or water droplets such as a bathroom or shower room.</p>

 **WARNING**

	<ul style="list-style-type: none"> <li>■ Do not place on an unstable location, or subject to impact. If the device is hit or dropped, an injury or damage or breakdown of the device can occur. Also, continued use of the device when it is not functioning properly can result in a fire or electrical shock. If the device is subjected to impact, immediately stop use, disconnect the USB cable, and contact your dealer or service company.</li> </ul>
	<p>Do not place in locations where oil is used. Oil can adhere to the device from oil smoke and other sources, resulting in a breakdown, fire, or electrical shock. Also, deterioration of the plastic can also cause the device to fall when installed in a high location, resulting in an injury.</p> <ul style="list-style-type: none"> <li>• Do not place in a locations with kitchens or locations where machine oil or other oils are used.</li> </ul>
	<ul style="list-style-type: none"> <li>■ Do not modify or disassemble.</li> <li>• A laser generator is installed inside the device, and if a laser beam is pointed directly at the eyes, it can cause an eye injury.</li> <li>• Please ask your dealer or service company to perform inspection, adjustment, repair, and cleaning of the inside of the device.</li> </ul>
	<ul style="list-style-type: none"> <li>■ Use the specified cables only. Use of improper cables can result in a fire, electrical shock, breakdown of the device, and electronic interference. Check beforehand that the cables supplied with the device are not scratched or otherwise damaged, and always use the supplied accessories. For details about other cable types, please consult your dealer or service company about suitable cables.</li> </ul>
	<ul style="list-style-type: none"> <li>■ Disconnect cables when cleaning. Cleaning while the cables are still connected can result in a fire or electrical shock. When cleaning, turn off the power, and disconnect the USB cables.</li> </ul>

**CAUTION**

- Do not place in hot locations.

When the device is placed in a hot location, the internal temperature can become extremely hot, resulting in a fire or breakdown of the device. Also, if the device is exposed to heat or warm air, the cabinet or other parts can be damaged.

- Do not place near sources of heat or expose to direct sunlight or warm air.
- Do not insert this device or any of its accessories into a microwave oven.
- Do not cover this device with a cloth or other object.



- Do not place in locations exposed to high humidity, large amounts of dust, smoke, or large amounts of salt.

If dust accumulates inside the device, a fire or electrical shock can result, or a breakdown or operation malfunction can occur. Do not place in locations exposed to high humidity or large amounts of dust. Also, if salt and mineral components contained in tap water are atomized by an ultrasonic humidifier or other device and adhere to this device, then a breakdown or malfunction can result.



Use of controls or adjustments or performance of procedures other than those specified herein may result in hazardous radiation exposure.

## Regulatory notices

About Electro-Magnetic Interference

### **In CANADA**

CAN ICES-3(B) / NMB-3(B).

### **In the US, and other places where the FCC regulations are applicable**

#### **Declaration of Conformity**

Trade name	HITACHI
Model Number	FT-01
Responsible Party	Hitachi America, Ltd.
Address	2420 Fenton Street, Suite 200 Chula Vista, CA 91914 U.S.A.
Telephone Number	+1 -800-448-2244

This device complies with part 15 of the FCC Rules. Operation is subject to the following two conditions: (1) This device may not cause harmful interference, and (2) this device must accept any interference received, including interference that may cause undesired operation. This equipment has been tested and found to comply with the limits for a Class B digital device, pursuant to Part 15 of the FCC Rules.

These limits are designed to provide reasonable protection against harmful interference in a residential installation. This equipment generates, uses, and can radiate radio frequency energy and, if not installed and used in accordance with the instructions, may cause harmful interference to radio communications. However, there is no guarantee that interference will not occur in a particular installation. If this equipment does cause harmful interference to radio or television reception, which can be determined by turning the equipment off and on, the user is encouraged to try to correct the interference by one or more of the following measures:

- Reorient or relocate the receiving antenna.
- Increase the separation between the equipment and receiver.
- Connect the equipment into an outlet on a circuit different from that to which the receiver is connected.
- Consult the dealer or an experienced radio/TV technician for help.

**INSTRUCTIONS TO USERS:** This equipment complies with the requirements of FCC (Federal Communication Commission) equipment provided that the following conditions are met. Some cables have to be used with the core set. Use the accessory cable or a designated-type cable for the connection. For cables that have a core only at one end, connect the core to the projector.

**CAUTION:** Changes or modifications not expressly approved by the party responsible for compliance could void the user's authority to operate the equipment.

## About Waste Electrical and Electronic Equipment

### Following information is only for EU-member states:

The mark shown to the right is in compliance with the Waste Electrical and Electronic Equipment Directive 2002/96/EC (WEEE).

The mark indicates the requirement NOT to dispose the equipment as unsorted municipal waste, but use the return and collection systems according to local law.



**NOTE** • Do not install near wireless transmitters, televisions, copy machines, cooling or heating equipment, or other devices that generate electromagnetic waves or wireless frequencies.

- Avoid installing in locations with large amounts of dust or locations with extremely high or low temperature or humidity.
- The Finger Touch function uses infrared rays to detect the position, and so avoid using in locations where the screen surface is exposed to direct sunlight. Also, if the Finger Touch function is used in environments where devices that emit infrared wavelength (such as incandescent lights, halogen lamps, plasma displays, motion sensors, and automatic lighting sensors) are used nearby, malfunctions may occur.
- The Finger Touch function may not work smoothly if installed near an inverter fluorescent lamp or if the light from an inverter fluorescent lamp shines on the screen.
- Install in a location that is not exposed to light sources, direct sunlight, and other strong beams of light. If a strong beam of light shines on the finger touch sensor (camera) or screen, the Finger Touch function may not work properly.
- Use by installing at a position where the screen size is 60 to 100 inches when the digital zoom is set to the maximum (100%) and the KEYSTONE and PERFECT FIT functions are not being used. If the KEYSTONE and PERFECT FIT functions are used, even if the screen size displayed after correction is 60 to 100 inches, the finger touch position may not be applied correctly to the screen, or the finger touch operation may not respond.

## IN the US







The following is the label conforming to FDA(21CFR1010.3).

Complies with 21 CFR 1040.10 and 1040.11 except for deviations pursuant to Laser Notice No. 50, dated June 24, 2007  
 • MANUFACTURER: ISCommunications Co., Ltd.  
 (SINMORA INDUSTRIAL ESTATE, MORA-DONG, 2F, MORA-RO 192BEON-GIL, SASANG-GU, BUSAN, 617-817 REP. OF KOREA  
 • BRAND HOLDER: Hitachi Maxell, Ltd.  
 5030 TOTSUKA-CHO, TOTSUKA-KU, YOKOHAMA, JAPAN  
 PLACE OF MANUFACTURE: KOREA / PACKAGED IN CHINA >RET<

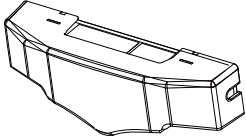
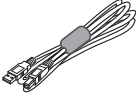
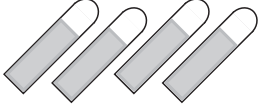
## Contents of package

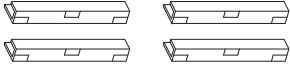
Check that the items listed in the table below are included in this package. If any are missing, please contact your dealer immediately.

Part names in the figures on the following pages are indicated by the symbols given in the table below.

Symbol	Part name	Quantity	Appearance
A	Finger Touch Unit	1	
B	USB cable	1	
C	Double-sided tape	4	
D	Magnetic sheet	3	
E	Fixing screw	2	
F	Adjusting bar	4	
G	Antireflection bar *	12	
H	IR FILTER **	1	
I	User's manual (this manual)	1	

\* Not used in normal use. Refer to P.26 for details.

\*\* Not used in normal use.



## Part names

### Adjusting knob

This knob is used to adjust the height and angle of the infrared laser beam.

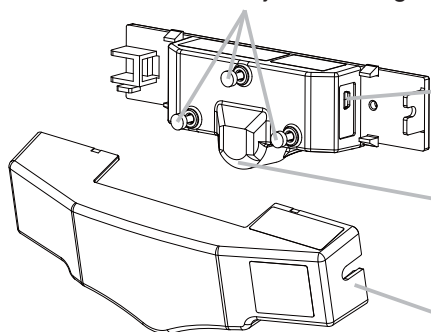

#### USB (B-type) mini-connector

This is connected to the option port of the projector.

#### Laser output port

This is the window where the infrared laser beam is output.

#### Cover

This is a protective cover that is mounted after installing and adjusting the Finger Touch Unit.

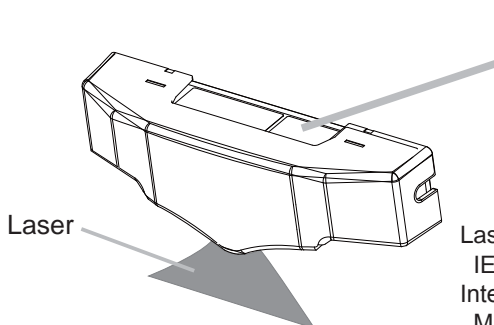

Laser evaluation standard:  
IEC60825-1: 2001, IEC60825-1: 2007  
Internal Laser Specifications  
Max. Output : 200mW  
Wave Length : 830nm



## WARNING



- This device is classified as a class 1 laser product.
- If the laser beam is pointed directly at the eyes, it can cause an eye injury.
- Do not look directly into the laser output port.
- Do not point the laser beam towards people.
- Do not allow children to use.

## Installation

### Installation Precautions

- This device is an optional product for the Hitachi LCD projectors. It cannot be used with other projectors.
- When this device is used, install the projector on a ceiling-mounted fixture or a tabletop use kit. It cannot be used for a floor-mounted installation.
- Install this product on a flat screen where the curvature or bending does not exceed 2 mm.

Curvature or bending of the screen can cut off the infrared laser beam generated by the Finger Touch Unit so that the Finger Touch function does not operate. Also, if the infrared laser beam generated by the Finger Touch Unit becomes too separated from the screen surface, the intended operation may be unable to be performed.

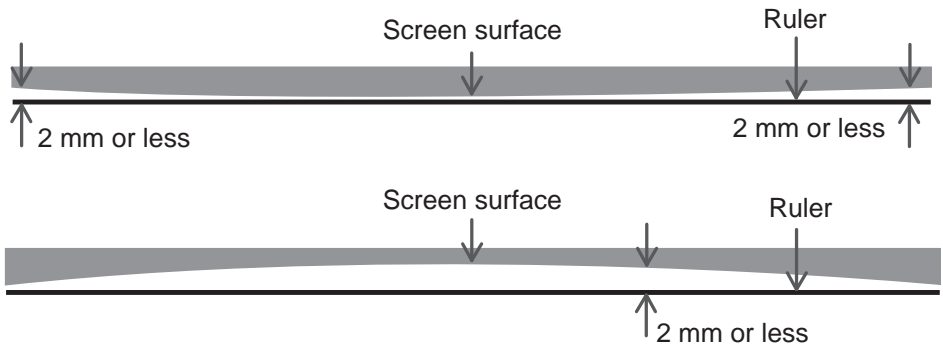

## FT-01

Install the Finger Touch Unit in the middle of the right and left edges of the projector display screen.

Set the gap between the laser output port of the Finger Touch Unit and the projector display screen to 50 to 100 mm.

To prevent malfunctions due to reflections on the screen frame on the screen right, left, and bottom edges, separate the projector display screen edge and screen edge by at least 50 mm.

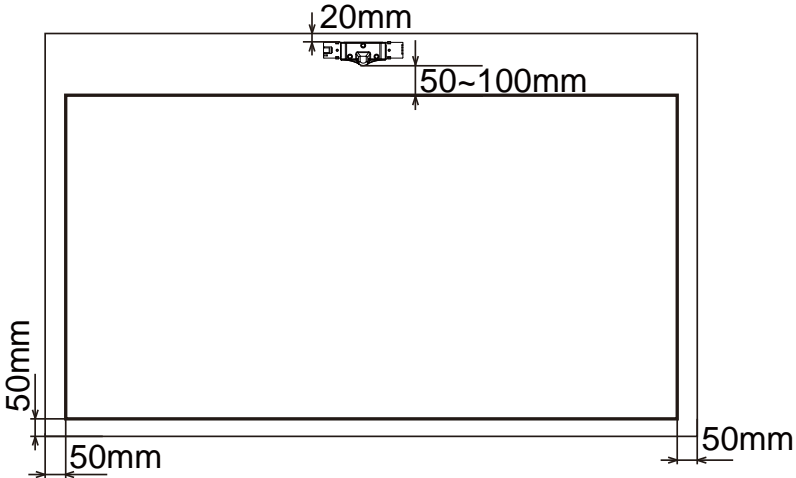

### CAUTION



Do not install the Finger Touch Unit on a wall.  
This could cause the wall paint or wallpaper to peel off.



Make a space of 20mm or more for attaching and detaching the cover when the Finger Touch Unit is fixed by the double-sided tape or the fixing screws.

## Installation Procedure



### WARNING



- The Finger Touch Unit should never be installed by the customer. Be sure to always request installation by your dealer or service company.
- Hitachi will not be liable for any accidents or injuries that occur due to improper installation or improper usage of this device.

#### ① Removing the cover

Remove the cover (a) from the Finger Touch Unit (A).

Insert your finger, and remove the cover while pulling downward.

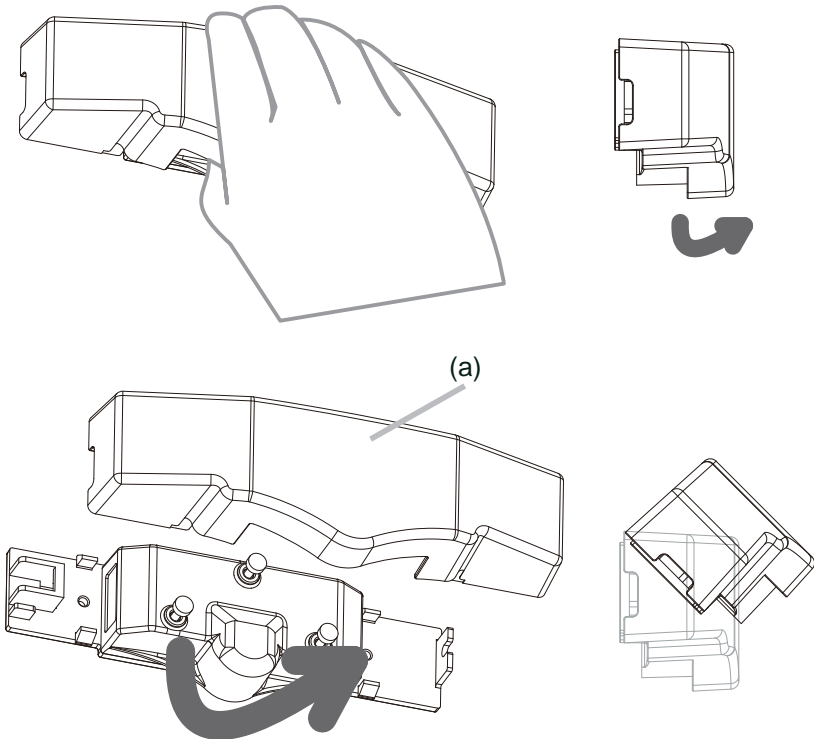

② Installing the Finger Touch Unit

Secure the Finger Touch Unit (A) in place using one of the three methods below.

(1) Securing using double-sided tape

- Peel off the backing paper (red side) of the double-sided tape (C), and affix four strips to the Finger Touch Unit as shown in the figure below. The performance may be deteriorated unless four strips of double-sided tape are used.
- Peel off the backing paper (black side) and press to adhere to the installation location.

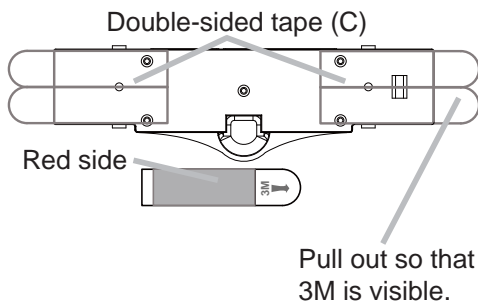

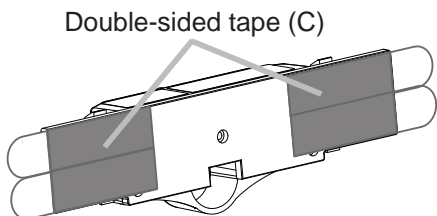

ENGLISH

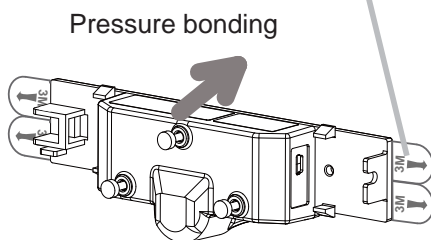

Black side

"かべ面", "WALL side", "Côté MUR", and "lado de la PARED" appear on this side.



 CAUTION	
○	×
Locations where installation is possible	Locations where installation is not possible
<ul style="list-style-type: none"> <li>• Flat, smooth surfaces</li> </ul>	<ul style="list-style-type: none"> <li>• Uneven, rough surfaces or curved surfaces</li> <li>• Wallpaper (vinyl, cloth, paper), clay walls, sand walls</li> </ul>

**NOTE** • When removing the Finger Touch Unit for dismantlement or other reasons, the double-sided tape is removed by pulling part (c).

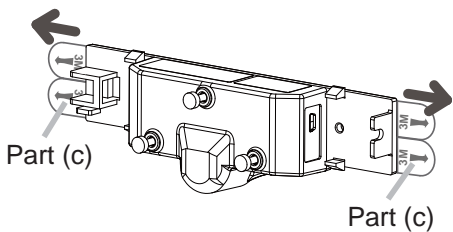

## FT-01

### ② Installing the Finger Touch Unit (continued)

#### (2) Securing using magnetic sheet

- Peel off the backing paper of the magnetic sheet (D), and affix three strips to the Finger Touch Unit as shown in the figure below.

Magnetic sheet (D)

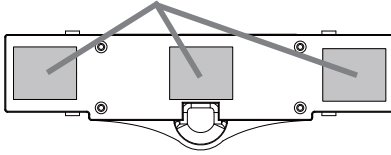

- Secure on a fixed location (metal).

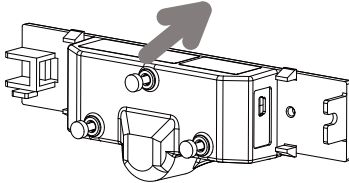

### ⚠ CAUTION



The magnet must be secured to a flat metal surface, and do not secure to bumpy metal surfaces.

#### (3) Installation using screws

- Secure using the two fixing screws (E).

Tightening torque:  $0.98\text{N} \cdot \text{m}$  (10kgf  $\cdot$  cm)

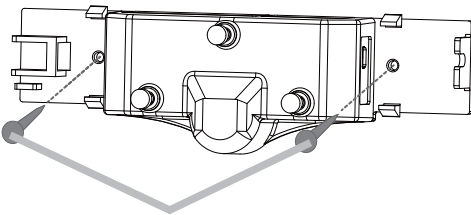

Fixing screws (E)

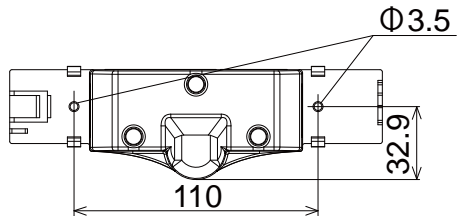

### ⚠ CAUTION



Be sure to always use screws when installing at heights of 2 meters or higher.

NOTE • The supplied screws are for thin plates and wood.

③ Connecting the USB cable (B)

(1) Use a Phillips-head screwdriver to remove the cover of the option port of the projector. Use the USB cable (B) to connect the Finger Touch Unit (A) to the projector option port.

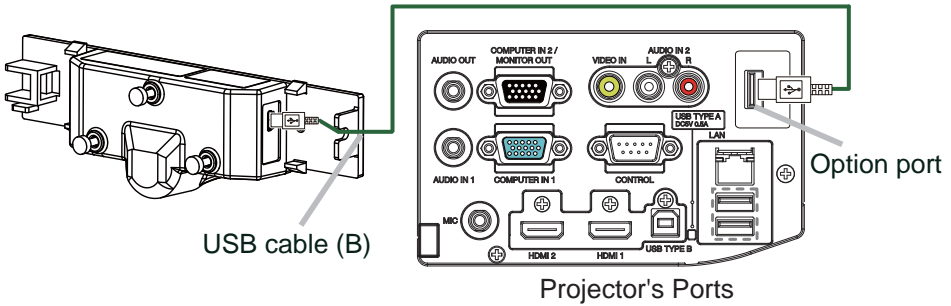

**CAUTION**

Before connecting the USB cable, check that the power supply is not connected to the projector. Be sure to always connect to the option port of the projector. Use caution when connecting because laser emission will start immediately if the USB cable is connected to the **USB TYPE A** port while the projector is connected to the power supply.

- The option port cover can be swallowed by children and pets. Keep it in a safe location out of the reach of children and pets. If it is swallowed, seek medical attention immediately.

- (2) Connect the computer to the projector by referring to "Connection during use" in the User's Manual (Detailed) Operating Guide for the projector.
- (3) Install the driver by referring to "Driver Installation" in the User's Manual (Detailed) Operating Guide for the projector.

## FT-01

### Using the drop-prevention bar

The Finger Touch Unit is provided with a drop-prevention bar that can be used with a commercially-available wire to prevent dropping of this device.

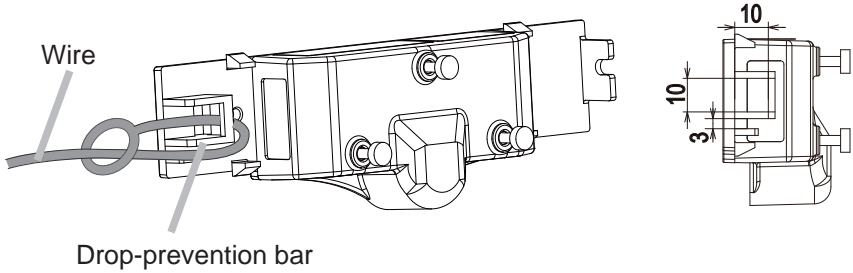

### Overall installation image

An image of the Finger Touch Unit installation is shown below.

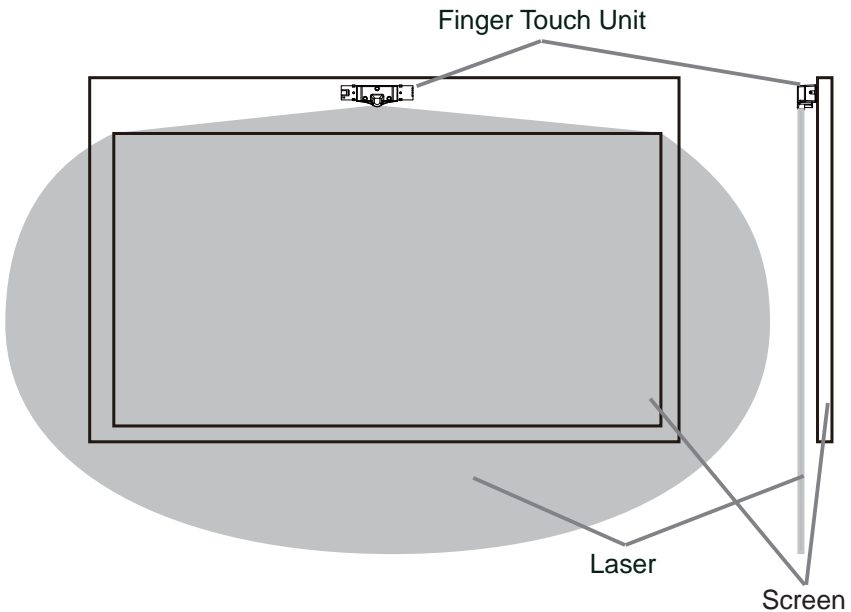

## CAUTION

The laser is output from the Finger Touch Unit in a radial shape. Do not look into the laser output port from the area shown in the figure. If the laser beam is pointed directly at the eyes, it can cause an eye injury.



## Finger Touch Unit adjustment procedure

The adjustment procedure using a Windows PC is shown below. If using a Mac PC, perform the same procedure by referring to the U-Pointer manual loaded in the DVD drive. Connect the projector **USB TYPE B** port and the computer USB TYPE A port using a USB cable, and press the **IWB** button on the remote control to change to WITH PC mode so that the DVD drive is recognized.

- (1) Use the **IWB** button on the remote control supplied with the projector to set the projector IWB MODE to "WITH PC".

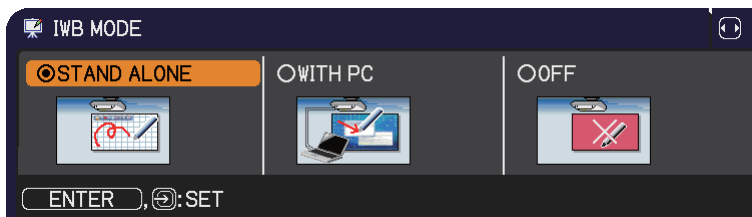

- (2) Click the U-Pointer icon in the task tray of the computer, and select [Configuration].

★ The displayed menu varies depending on the language setting. ★

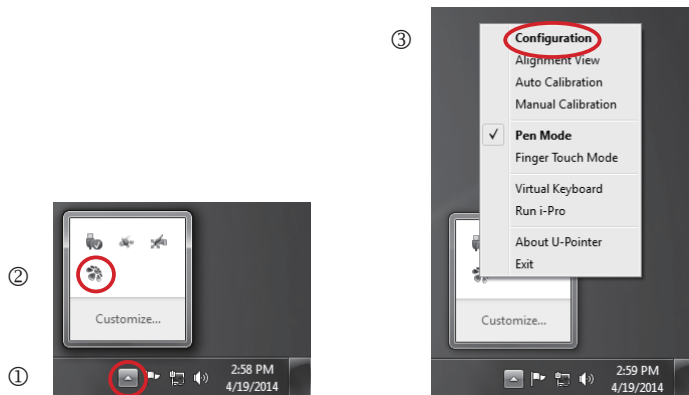

## FT-01

(3) Set U-Pointer Configuration as shown in the figure below.

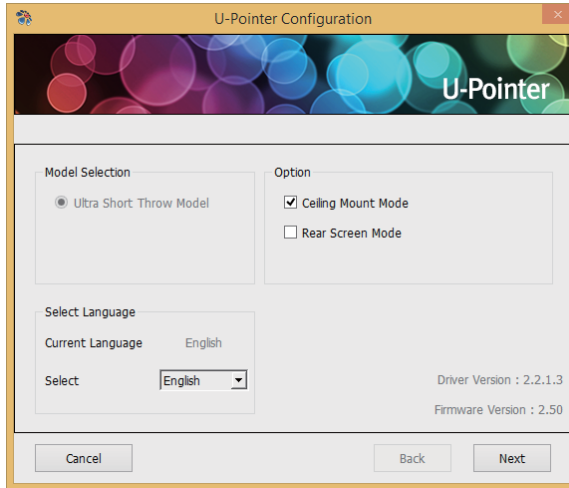

(4) Once the confirmation screen is displayed, click [Finish].

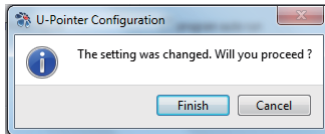

(5) Click [Next] → [Alignment View] to open the Alignment View.

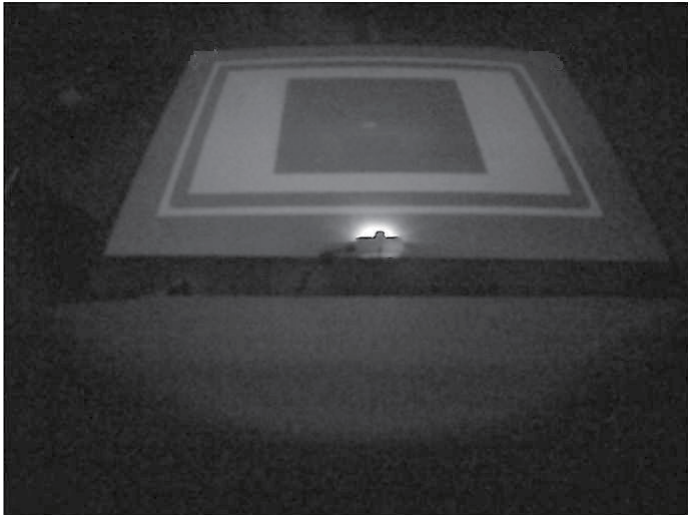

## FT-01

- (6) Secure the supplied adjusting bars (F) to the right and left edges of the projector display screen. Align the white print surface of the Adjusting bar toward the direction of the Finger Touch Unit, and use the supplied double-sided tape to secure in place.

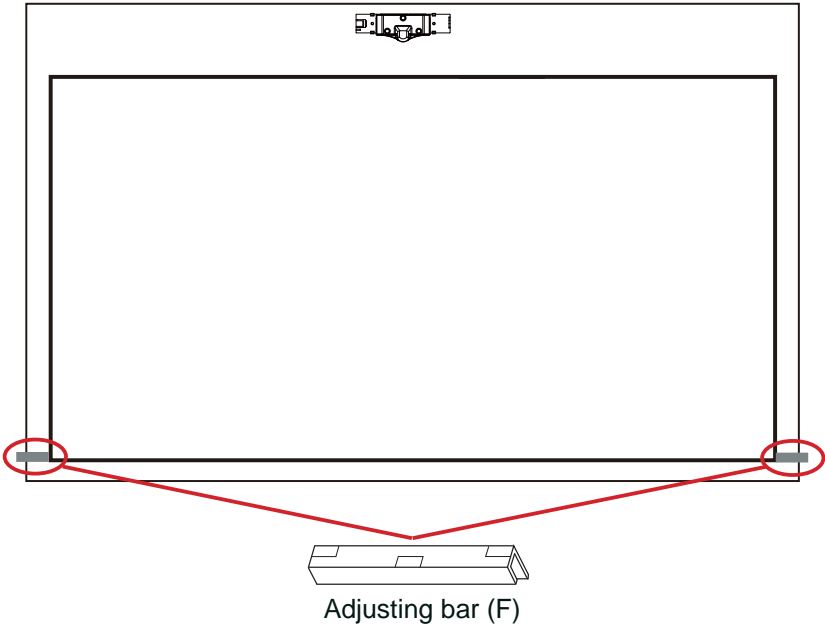

- (7) Set all the adjusting knobs ①②③ so that they protrude about 8mm from the case.

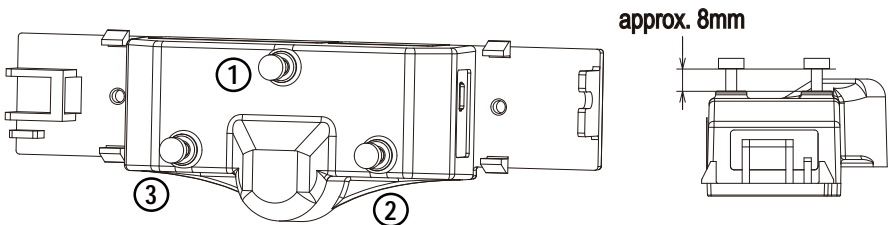

## FT-01

- (8) Turn the adjusting knob ② clockwise until the reflection line in the screen appears.

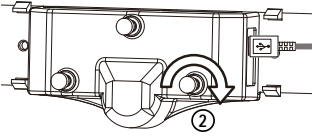

- (9) Turn the adjusting knob ③ clockwise so that the reflection line is horizontal.

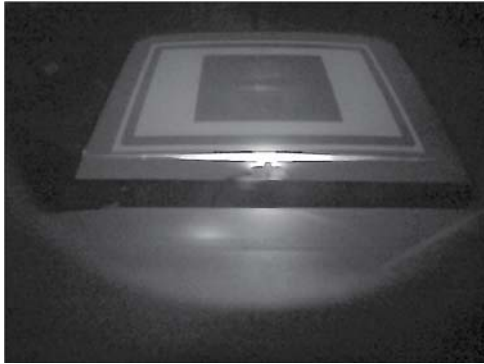
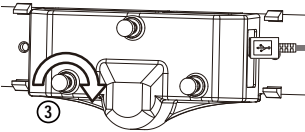

- (10) Turn the adjusting knob ① clockwise so that the reflection line moves near the vertical center.

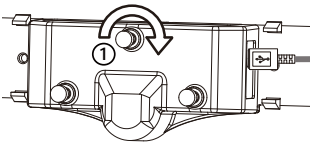

## FT-01

- (11) If the reflection line is not horizontal, use adjusting knobs ② or ③ to make the reflection line horizontal.

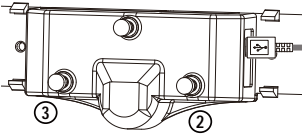

- (12) Turn the adjusting knob ① clockwise until only one Adjusting bars each appears at the bottom right and bottom left of the screen.

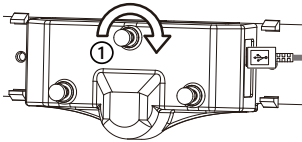

- (13) Turn the adjusting knob ① counter-clockwise until two Adjusting bars each appear at the bottom right and bottom left of the screen.

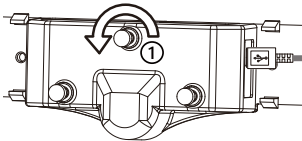

**NOTE** • If no beam is coming from the laser output port, the laser may have failed.

## FT-01

- (14) Touch your finger on the projector display screen, and check that your fingertip is lit up within the display screen when the distance between your fingertip and the screen is about 5 mm or less.

**NOTE**

- If the distance between the infrared laser beam and screen is too far, turn all the adjusting knobs ① ② ③ clockwise, and then perform the adjustment from steps (8) to (14) again.
- If the distance between the infrared laser beam and screen is too near, turn all the adjusting knobs ① ② ③ counter-clockwise, and then perform the adjustment from steps (8) to (14) again.

- (15) Gently attach the cover so that it does not touch the adjusting knobs.

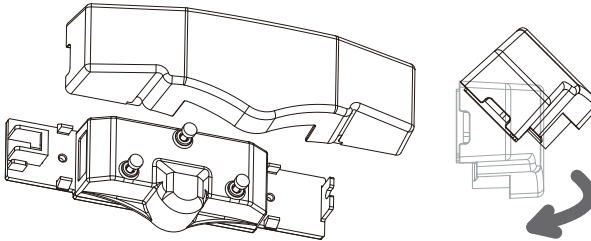

**NOTE**

- In case that the Finger Touch Unit is fixed by the magnetic sheet, it may also come off when removing the cover.

- (16) Remove the Adjusting bars from the screen.
- (17) Click [OK] to exit the Alignment View.
- (18) Click [Next] → [Auto Calibration] to execute Auto Calibration. If Auto Calibration fails, perform Manual Calibration.
- (19) Click [Finish] to exit the U-Pointer Configuration.

(20) Click the U-Pointer icon in the task tray of the computer, and select [Finger Touch Mode].

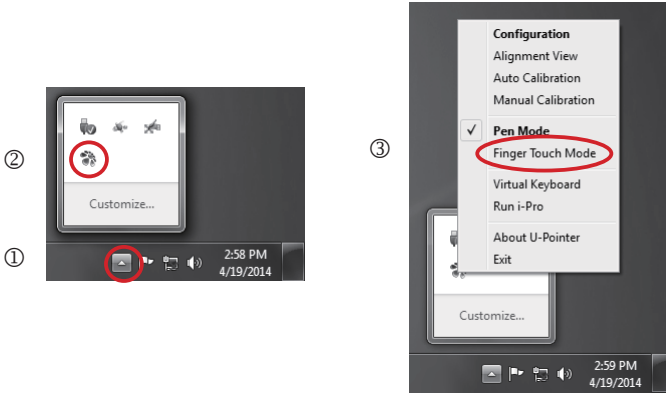

This completes the adjustment of the Finger Touch Unit.

## Basic Finger Touch Operations

Finger touch operations can be used to perform Windows mouse operations.

- Left-click  
Touching the screen with your finger performs a clicking operation.
- Double-click  
Performing two quick clicking operations results in a double-clicking operation.
- Right-click  
Touching the same location on the screen with your finger for two seconds performs a mouse right-click operation.
- Drag  
Moving your finger while touching the screen performs a dragging operation.

## Inspection and Cleaning

Cleaning the Finger Touch Unit

1. Turn off the projector power, and disconnect the USB cable from the Finger Touch Unit.
2. Gently wipe with a soft, dry cloth.

## Troubleshooting



### WARNING

If any problems occur, immediately disconnect the cables, and contact your dealer or service company.

### Phenomena that may be easy to be mistaken for machine defects

About the phenomenon confused with a machine defect, check and cope with it according to the following table.

Problem	Checkpoints	Ref. page
Finger Touch function does not operate.	Is the projector positioned too close to the screen? Use by installing at a position where the screen size is 60 to 100 inches when the digital zoom is set to the maximum (100%) and the KEYSTONE and PERFECT FIT functions are not being used.	6
	Did you perform the finger touch positioning alignment? Perform "CALIBRATE" from the projector menu.	—
	Are the projector and screen used at the following places? • Near light sources that include a strong infrared component such as white incandescent bulbs and halogen lamps. • Place that is exposed to direct sunlight. • Place near an inverter fluorescent light. • Near infrared wireless microphones.	6
	Is ambient light falling on the screen? Darken illumination or close the curtain so that the light cannot fall on the screen as much as possible.	6
	Is transmission between the screen and the sensor obstructed? Make sure that the area between the sensor at the top surface of the projector and the screen is not obstructed (transparent and meshed objects are also not allowed). For example, the Interactive Function does not function if the projector is enclosed with only the lens exposed, such as when a casing for theft prevention is used.	—
	Is the camera lens dirty? If the camera lens is dirty, wipe it off with a lens cleaning cloth.	—
	Other than those above Disconnect the USB cable connecting the projector and computer, and then try connecting it again.	—



Troubleshooting (Continued)

Problem	Checkpoints	Ref. page
Finger Touch function does not operate. (continued)	If no beam is coming from the laser output port, the laser may have failed.	20
The fingertip and cursor are not aligned.	Did you perform the finger touch positioning alignment? Perform "CALIBRATE" from the projector menu.	—
	Is the projector installed in a tilted position? After reinstalling the projector in a level position, perform "CALIBRATE" from the projector menu.	—
	Actual resolution may be different due to output image with a black frame depending on the type of laptop PC. In this case, perform calibration of driver software U-Pointer. Calibration may be necessary again when you use different PC.	—
The finger touch operations are unstable or stop.	Is the power supply for the projector used at the same time for other electrical products that require a measurable amount of power? Use a separate power supply for other electrical products with a high power consumption.	—
	Is driver software U-Pointer set to "Pen Mode"? When using the Finger Touch function, set U-Pointer to "Finger Touch Mode".	21
	Adjustment of the Finger Touch Unit may have shifted. Perform the re-adjustment.	—

Troubleshooting (Continued)

Problem	Checkpoints	Ref. page
The finger touch operations are unstable or stop. (continued)	Malfunction may have occurred due to the laser reflected on an obstacle around the screen. Perform up to step (5) of the Finger Touch Unit adjustment procedure (📖17) to display Alignment View. Perform the followings when there is an obstacle emitting light around the screen as the following figure. • Confirm that the obstacles do not emit light after removing them around the screen. • Confirm that the obstacles do not emit light after sticking the antireflection bar (G) between the reflector and the Finger Touch Unit when they cannot be removed.	16
	Other than those above • Disconnect the power supply for the projector and connect again. • Restart Windows®.	—

Peel off the backing paper of the antireflection bar and stick it to the installation location.

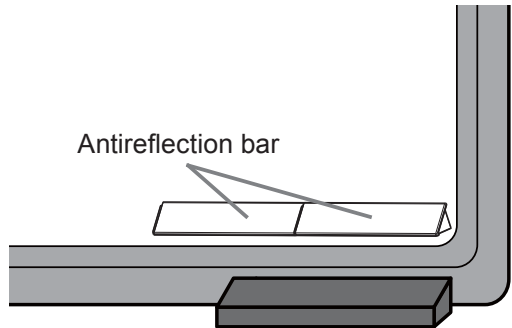

**⚠ CAUTION**

- Do not detach the antireflection bar. Adhesive strength of the tape decreases.
- Do not detach the antireflection bar. A sticking surface may be broken.
- The antireflection bar does not work properly when something like a tape is stuck on it.

Troubleshooting (Continued)

Problem	Checkpoints	Ref. page
<p>The finger touch positioning alignment cannot be performed correctly.</p>	<p>Are the Finger Touch Unit and projector installed correctly? Check each installation position.</p>	<p>10</p>
	<p>Is the computer image projected within the area of the screen? Use by installing at a position where the screen size is 60 to 100 inches when the digital zoom is set to the maximum (100%) and the KEYSTONE and PERFECT FIT functions are not being used. If the KEYSTONE and PERFECT FIT functions are used, even if the screen size displayed after correction is 60 to 100 inches, the finger touch position may not be applied correctly to the screen, or the finger touch operation may not respond.</p>	<p>6</p>
	<p>Is a part of the image enlarged using the Magnify function? Press the <b>MAGNIFY OFF</b> button on the remote control to restore the normal display.</p>	<p>—</p>
	<p>Is ASPECT set to NATIVE and the display resolution of the computer larger than 1280 x 800? Set ASPECT to NORMAL, or set the display resolution of the computer to lower than 1280 x 800.</p>	<p>—</p>
	<p>Is ambient light falling on the screen? Darken illumination or close the curtain so that the light cannot fall on the screen as much as possible.</p>	<p>6</p>
	<p>AUTO CALIBRATE may fail when the shadow of a person is reflected on the screen. Stay away from the screen when performing AUTO CALIBRATE.</p>	<p>—</p>
	<p>Perform MANUAL CALIBRATE when AUTO CALIBRATE failed many times.</p>	<p>—</p>

## Specifications

Item	Specification
Model	FT-01
Power supply/Rated current	DC 5V/200mA
Power consumption	1W
Temperature range	0~40°C (Operating)
Size	178 (W) x 58 (H) x 44 (D) mm * Not including protruding parts. See figure below.
Weight (mass)	approx. 110g

## External View

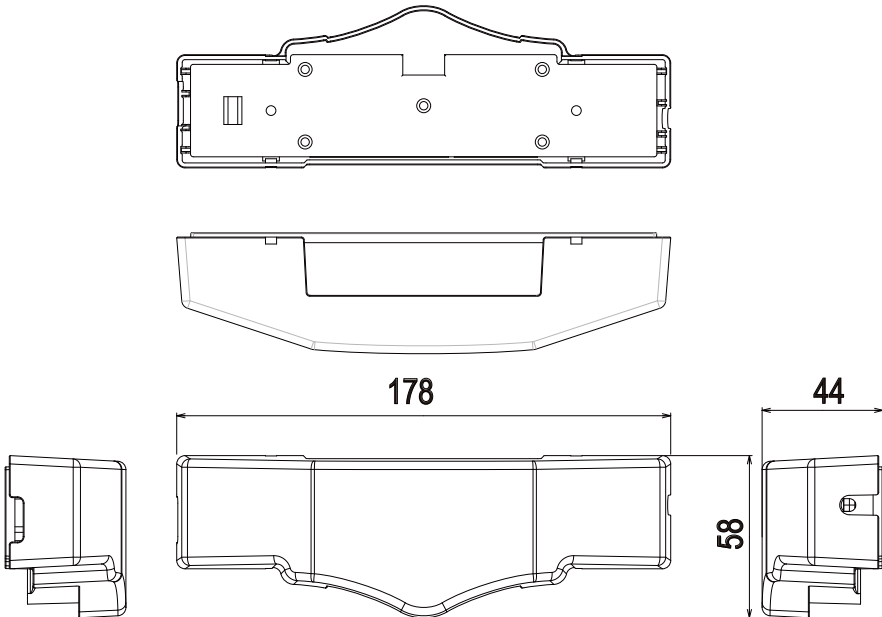

### **Trademark acknowledgment**

- Microsoft®, Windows® are registered trademarks of Microsoft Corporation in the U.S. and/or other countries.
- Mac®, Macintosh® and Mac OS® are registered trademarks of Apple Inc.

All other trademarks are the properties of their respective owners.